

SF812 SMOKE DETECTOR

The photoelectric Smoke Detector is a Z-Wave™ enabled device which is fully compatible with any Z-Wave™ enabled network. Z-Wave™ enabled devices displaying the Z-Wave™ logo can also be used with it regardless of the manufacturer, and ours can also be used in other manufacturer's Z-Wave™ enabled networks. Inclusion of this detector on other manufacturer's Wireless Controller menu allows remote operation of connected modules when the detector is triggered.

The detector is designed to sense smoke that comes into the detector chamber. It does not sense gas, heat, or flame. The working principle is when the smoke detector detects a certain density of smoke, the horn of smoke detector will sound and in the meantime, the detector will emit the signals to the associated devices for further execution. It can provide precious time for you and your family to escape before a fire spreads.

Product Overview

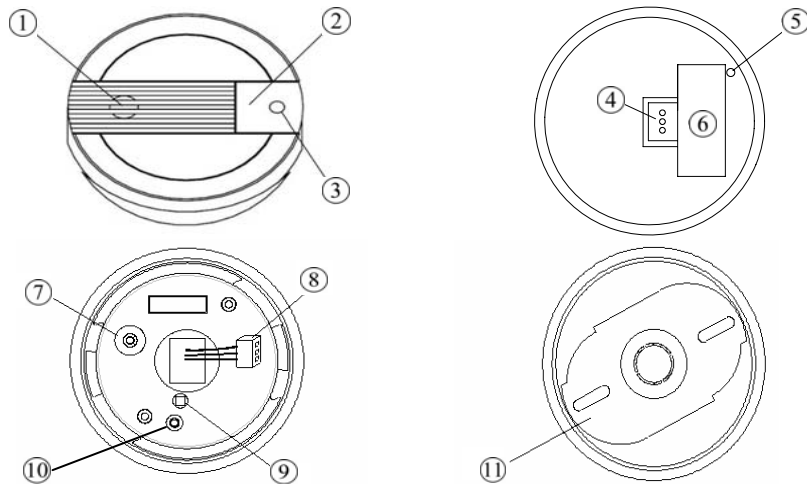

① Horn	⑦ Link Key
② Test Button	⑧ Connector
③ LED	⑨ Tamper Switch
④ Connector's Hole	⑩ Link LED
⑤ Cover Latch	⑪ Mounting Bracket
⑥ Battery Cover	

Include to or Exclude from a Z-Wave™ Network

Inside the detector, there is a link key which is used to carry out the function of inclusion, exclusion, association and reset. When first power is applied, its LED flashes on and off alternately and repeatedly for 4 minutes, which implies that it has not been assigned a node ID and cannot work with Z-Wave enabled devices. Please get familiar with the terms below before starting the operations.

Function	Description
Inclusion	Add a Z-Wave enabled device (e.g. Smoke Detector) to Z-Wave network.
Exclusion	Delete a Z-Wave enabled device (e.g. Smoke Detector) from the network.
Association	After inclusion, you have to define the relationship between devices. Through association, device can be assigned as master/slave, and specify which slave is going to be controlled by which master.
Reset	Restore Smoke Detector to factory default.

The table below lists an operation summary of basic Z-Wave functions. Please refer to the instructions for your Z-Wave™ Certified Primary Controller to access the setup function, and to include/exclude/associate devices.

Action/Status	Description	Link LED Indication
No node ID	The Z-Wave Controller does not allocate a node ID to the detector.	2-second on, 2-second off
Inclusion	1. Have Z-Wave Controller entered inclusion mode.	Flashes when link key is pressed
	2. Pressing link key three times within 1.5 second will enter inclusion mode. The Detector will stay "awake" for 10 minutes to allow time for setting and device status enquiring.	
Exclusion	1. Have Z-Wave Controller entered exclusion mode.	Flashes when link key is pressed
	2. Pressing link key three times within 1.5 second will enter exclusion mode. The Detector will stay "awake" for 10 minutes to allow time for setting and device status enquiring.	
	Node ID has been excluded.	2-second on, 2-second off

Action/Status	Description	Link LED Indication
Reset	1. Pressing link key three times within 1.5 second will enter exclusion mode	Flashes when link key is pressed
	2. Within 1 second, press link key again and hold it until LED is off	LED is on for 5 seconds
	3. Node ID is excluded, and it sets the device back to factory default state.	2-second on, 2-second off
Association	1. Have Z-Wave Controller entered association mode.	Flashes when link key is pressed
	2. Pressing link key 3 times within 1.5 second will enter association mode	
	3. Refer to group support as described on page 5	
* Failed or success in including/excluding the node ID can be viewed from the Z-Wave Controller.		

Choosing a Mounting Location

The detector is designed for use in a single residential unit only, such as a single family home or apartment. It is not meant to be used in lobbies, hallways, basements, or another apartment in multi-family buildings, unless there are already working detectors in each family unit. Smoke detectors, placed in common areas outside of the individual living unit, such as on porches or in hallways, may not provide early warning to residents. In multi-family buildings, each family living unit should set up its own detectors.

The detector is not meant to be used in non-residential buildings. Warehouses, industrial or commercial buildings, and special purpose non-residential buildings require special fire detection and alarm systems. This detector is not a suitable substitute for complete fire detection systems for places where many people live or work, such as hotels or motels. The same is true of dormitories, hospitals, nursing homes or group homes of any kind, even if they were once single family homes.

For complete coverage in residential units, it should be installed in all rooms, halls, storage areas, basements and attics in each family living unit. Minimum coverage is one detector on each floor and one in each sleeping area. Useful tips are listed hereunder:

1. Install a detector in the hallway outside every separate bedroom area as shown in FIGURE 1. Two detectors are required in homes with two bedroom areas as shown in FIGURE 2.

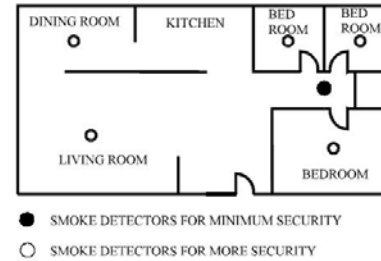

FIGURE 1
Locations for placing smoke detectors for single residence with only one sleeping area.

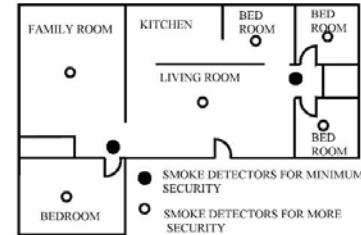

FIGURE 2
Locations for placing smoke detectors for single-floor residence with more than one sleeping area.

2. Install a detector on every floor of a multi-floor home or apartment as shown in FIGURE 3.

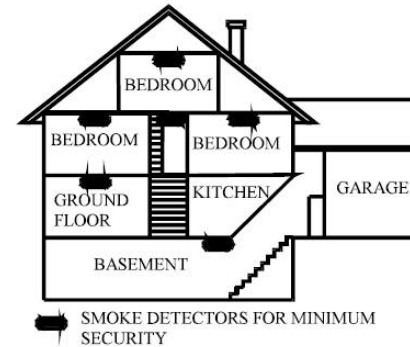

FIGURE 3
Locations for placing smoke detectors for a multi-floor residence.

3. Install a minimum of two detectors in any household.
4. Install a detector inside every bedroom.
5. Install smoke detectors at both ends of a bedroom hallway if the hallway is more than 40 feet (12 meters) long.
6. Install a detector inside every room where one sleeps with the door partly or completely closed, since smoke could be blocked by the closed door and a hallway alarm may not wake up the sleeper if the door is closed.
7. Install detectors as close to the center of the ceiling as possible. If this is not practical, put the detector on the ceiling, no closer than 4 inches (10 cm) from any wall or corner as shown in FIGURE 4.

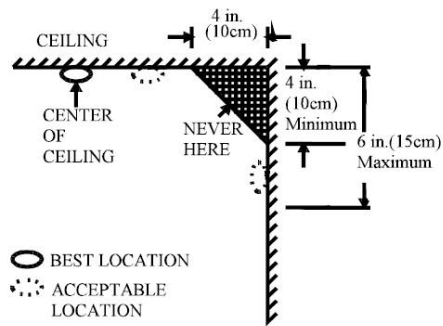

FIGURE 4
Recommended best and acceptable locations to mount smoke detectors.

8. If ceiling mounting is not possible, put wall-mounted detectors between 4 and 6 inches (10~15 cm) from the ceiling (FIGURE 4).
9. If some of your rooms have sloped, peaked, or gabled ceilings, try to mount detectors 3 feet (0.9 meter) measured horizontally from the highest point of the ceiling as shown in FIGURE 5.

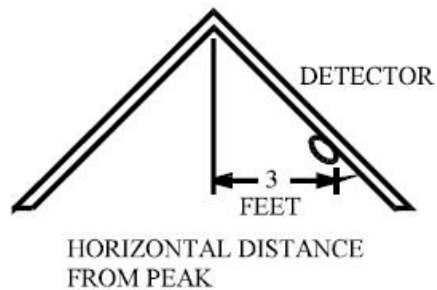

FIGURE 5
Recommended location to mount smoke detectors in rooms with sloped, gabled or peaked ceiling.

Locations Not To Install the Detector

Nuisance alarms take place when smoke detectors are installed where they will not work properly. To avoid nuisance alarms, do not install smoke detectors in the following situations:

1. Combustion particles are the by-products of something that is burning. Thus, in or near areas where combustion particles are present you do not install the smoke detectors to avoid nuisance alarms, such as kitchens with few windows or poor ventilation, garages where there may be vehicle exhaust, near furnaces, hot water heaters, and space heaters.
2. Do not install smoke detectors less than 20 feet (6 meters) away from places where combustion particles are normally present, like kitchens. If a 20-foot

distance is not possible, e.g. in a mobile home, try to install the detector as far away from the combustion particles as possible, preferably on the wall. To prevent nuisance alarms, provide good ventilation in such places.

IMPORTANT: For any reason, do not disable the detector to avoid nuisance alarms.

3. When air streams passing by kitchens, the way how a detector can sense combustion particles in normal air-flow paths is graphically shown in FIGURE 6, which indicates the correct and incorrect smoke detector locations concerning this problem.

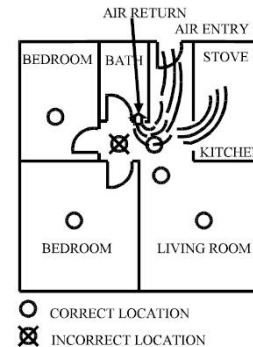

FIGURE 6
Recommended smoke detector locations to avoid air streams with combustion particles.

4. In damp or very humid areas, or near bathrooms with showers. Moisture in humid air can enter the sensing chamber, then turns into droplets upon cooling, which can cause nuisance alarms. Install detectors at least 10 feet (3 meters) away from bathrooms.
5. In very cold or very hot areas, including unheated buildings or outdoor rooms. If the temperature goes above or below the operating range of smoke detector, it will not work properly. The temperature range for your smoke detector is 4°C to 38°C (40°F to 100°F).
6. In very dusty or dirty areas, dirt and dust can build up on the detector's sensing chamber, to make it overly sensitive. Additionally, dust or dirt can block openings to the sensing chamber and keep the detector from sensing smoke.
7. Near fresh air vents or very drafty areas like air conditioners, heaters or fans, fresh air vents and drafts can drive smoke away from smoke detectors.
8. Dead air spaces are often at the top of a peaked roof, or in the corners between ceilings and walls. Dead air may prevent smoke from reaching a detector. Refer to FIGURE 4 and 5 for recommended mounting locations.
9. In insect-infested areas, it is probable that the insects may enter a detector's

sensing chamber to cause a nuisance alarm. Where bugs are a problem, please get rid of them before putting up a detector.

10. Near fluorescent lights, electrical “noise” from fluorescent lights may cause nuisance alarms. Install smoke detectors at least 5 feet (1.5 meters) away from such lights.

WARNING: Never remove batteries to stop a nuisance alarm. Cooking smoke or a dusty furnace, sometimes called “friendly fires” can cause the alarm to sound. If this happens, open a window or fan the air around the detector to get rid of the smoke or dust. The alarm will turn itself off when the smoke is gone. If nuisance alarms persist, attempt to clean the detector as described in this Manual.

WARNING: Do not stand close to the detector when the alarm is sounding. The alarm is loud in order to wake you in an emergency. Too much exposure to the horn at close range may be harmful to your hearing.

Installation

1. At the place where you are going to install the detector, draw a horizontal line six inches long.
2. Remove the mounting bracket from the detector by rotating it counterclockwise. (FIGURE 7)



FIGURE 7

3. Place the bracket so that the two longest hole slots are aligned on the line. In each of keyhole slots, draw a mark to locate a mounting plug and screw.
4. Remove the bracket.
5. Using a 3/16-inch (5mm) drill bit, drills two holes at the marks and insert plastic wall plugs. Put the detector away from getting plaster dust on it when you drill holes for mounting.
6. Using the two screws and plastic wall plugs (all supplied), attach the bracket to the wall.
7. Line up the slot of the bracket and the detector. Push the detector onto the mounting bracket and turn it clockwise to fix it into place. (FIGURE 8) Pull outward on the detector to make sure it is securely attached to the mounting bracket.

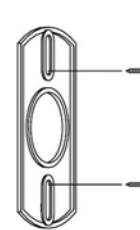

FIGURE 8

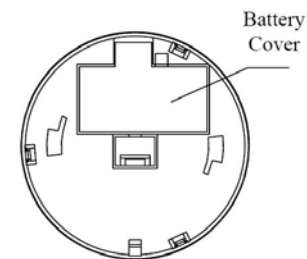
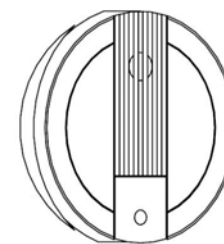

FIGURE 9

8. The steps to open the battery cover and to install the battery are listed as follows:

- a. To power the detector requires a 9V alkaline battery.
- b. Open the battery cover and connect the battery with +ve and –ve in the correct position. Push battery firmly in until it snaps and cannot be shaken loose.

NOTE: It comes with cover latches that will prevent the battery cover from closing if battery is not installed. (FIGURE 9) This tells you that the smoke detector will not work until a new battery is properly installed.

- c. Place the connector to the connector hole. Ensure that the direction of connector is inserted correctly according to the sticker affixed on the detector. (FIGURE 10)

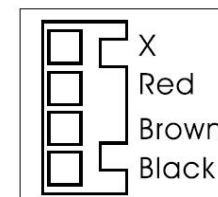

FIGURE 10

Operation

1. The detector sounds as long as the test button is pressed for 3 seconds or there is smoke in the detector. When the detector goes off, always check carefully to see that there is no fire and never remove the battery from the detector except when changing it!
2. Always test the detector immediately after returning from holiday, after a longer period of absence or periodically to ensure the detector functions normally. Under the test button, there is a red control LED which flashes once every 30

seconds. It indicates the detector is under normal operation. When Smoke Detector senses smoke and simultaneously sounds an audible alarm, the red LED will flash frequently, once 0.67 seconds. If the detector does not sound when testing, the battery must be replaced.

WARNING: Never use an open flame to test your detector. You may set fire to damage the detector, as well as your home.

WARNING: When you are not testing the unit and the alarm horn sounds a loud continuous sound, this means the detector has sensed smoke or combustion particles in the air. Be sure that the alarm horn is a warning of a possible serious situation, which requires your immediate attention.

Programming

1. Z-Wave's Group (Association Command Class Version 2)

The Smoke Detector supports one association group with five nodes. This has the effect that when the detector is triggered, all devices associated with the detector will receive the relevant reports. There are two main kinds of reports: ALARM_REPORT and SENSOR_ALARM_REPORT. Please refer to the sections below for more details on the reports that the detector will emit when event occurs.

1.1 POWER_APPLIED command

The Smoke Detector will send ALARM_REPORT command to the nodes of Grouping 1 to inform the devices that the detector is powered up.

ALARM_REPORT Command:
[Command Class Alarm, Alarm Type = 0x02, Alarm Level = 0x01]

1.2 Smoke Event Report

Once the detector has been triggered by smoke, the detector will send SENSOR_ALARM_REPORT (Sensor State = 0xFF) to the nodes of Grouping 1 to inform them there is a smoke event; wait till the smoke is discharged, SENSOR_ALARM_REPORT (Sensor State = 0x00) will be sent to the associated devices.

SENSOR_ALARM_REPORT

Event Present:

[Command Class Sensor Alarm, Sensor Alarm Report, Sensor Type Smoke Alarm State = 255 (0 x FF), Seconds = 0x00]

Event Clear:

[Command Class Sensor Alarm, Sensor Alarm Report, Sensor Type Smoke Alarm State = 0, Seconds = 0x00]

1.3 Tamper Trigger Report

When the tamper is triggered (that is, the detector is opened with tamper switch being released), the detector will emit ALARM_REPORT command to the nodes of Grouping 1.

ALARM_REPORT Command:
[Command Class Alarm, Alarm Type = 0x01, Alarm Level = 17(0x11)]

Note: If you press test button under low battery status while tamper switch is released, the status LED will flash once.

1.4 Low Battery Report

When the battery level of the detector drops to an unacceptable level, the detector will sound once every 30 seconds and send BATTERY_REPORT command to the nodes of Grouping 1 once per hour.

BATTERY_REPORT Command:
[Command Class Alarm, Alarm Type = 0x01, Alarm Level = 255(0xFF)]

The users can also enquire the battery status of the detector by sending BATTERY_GET command via controller, however, this procedure can only be done during 5-second time allowance after the tamper switch/detector being triggered or 10 minutes wakeup time when power is first applied. Once the detector receives the command, it will return BATTERY_REPORT command.

BATTERY_REPORT Command:
[Command Class Battery, Battery Report, Battery Level = 20%-100%]

If it displays with a message of "Battery Level = 255 (0xFF)", it implies that the detector is at low battery status. Please replace the batteries as soon as possible.

2. Command Classes

The Smoke Detector supports Command Classes including...

- * COMMAND_CLASS_BATTERY
- * COMMAND_CLASS_VERISON
- * COMMAND_CLASS_SENSOR_ALARM
- * COMMAND_CLASS_ASSOCIATION_V2
- * COMMAND_CLASS_MANUFACTURER_SPECIFIC

Maintenance

The smoke detector is preferably powered by a 9V alkaline battery which under normal conditions will have typical life in excess of 1 year. Replace the battery once a year. When changing the battery, clean and vacuum the dust off the detector's sensing chamber carefully using a soft brush.

Troubleshooting

Symptom	Possible Cause	Recommendation
LED not illuminating, the detector not working	Run out of battery power; check if reverse battery polarity	Replace a new battery
	Check if the detector is out of order	Do not open the detector; send it to the local retailer.
LED cannot be displayed and the detector not working when pressing the test button	Reverse battery polarity or poor battery connections	Refit the battery with correct polarity
	Run out of battery power	Replace a new battery
	Button pressing time is not long enough; it should be pressed and held for more than 1 second	Press and hold the button for longer than 1 second
The detector does not stay awake for 10 minutes when power is first supplied	Check if detector is out of order	Remove the battery, press link key several times to release the existing battery power and wait for approx.10 seconds before replacing the battery.

Specifications

Operating Frequency	868.42 MHz (SF812-1) / 908.42 MHz (SF812-2)
Battery Type	9V alkaline battery x 1
Operating Range	Up to 30 meters line of sight (indoor)
ZDK Version	V5.02

**Specifications are subject to change without notice*

A501111353R01



Federal Communication Commission Interference Statement

This equipment has been tested and found to comply with the limits for a Class B digital device, pursuant to Part 15 of the FCC Rules. These limits are designed to provide reasonable protection against harmful interference in a residential installation. This equipment generates, uses and can radiate radio frequency energy and, if not installed and used in accordance with the instructions, may cause harmful interference to radio communications. However, there is no guarantee that interference will not occur in a particular installation. If this equipment does cause harmful interference to radio or television reception, which can be determined by turning the equipment off and on, the user is encouraged to try to correct the interference by one of the following measures:

- Reorient or relocate the receiving antenna.
- Increase the separation between the equipment and receiver.
- Connect the equipment into an outlet on a circuit different from that to which the receiver is connected.
- Consult the dealer or an experienced radio/TV technician for help.

This device complies with Part 15 of the FCC Rules. Operation is subject to the following two conditions: (1) This device may not cause harmful interference, and (2) this device must accept any interference received, including interference that may cause undesired operation.

FCC Caution: Any changes or modifications not expressly approved by the party responsible for compliance could void the user's authority to operate this equipment.

This transmitter must not be co-located or operating in conjunction with any other antenna or transmitter.

WARNING:

Do not dispose of electrical appliances as unsorted municipal waste, use separate collection facilities.

Contact your local government for information regarding the collection systems available.

If electrical appliances are disposed of in landfills or dumps, hazardous substances can leak into the groundwater and get into the food chain, damaging your health and well-being.

When replacing old appliances with new ones, the retailer is legally obligated to take back your old appliance for disposal at least for free of charge.